

- PINCE DE TERRE
- GROUND TESTER
- ERDUNGSPRÜFZANGE
- PINZA DI TERRA
- PINZA DE TIERRA

C.A 6410
C.A 6412
C.A 6415
C.A 6415R

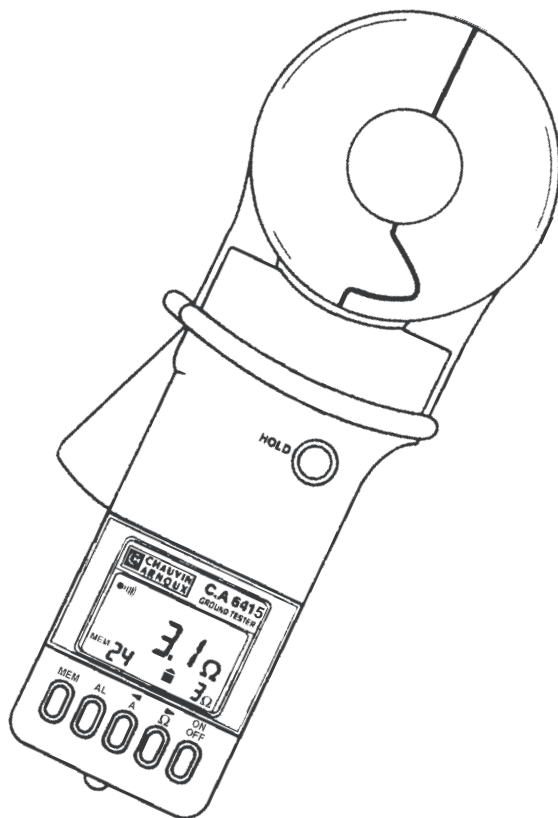

FRANCAIS
ENGLISH
DEUTSCH
ITALIANO
ESPANOL

Notice de fonctionnement
User's Manual
Bedienungsanleitung
Libretto d'Istruzioni
Manual de Instrucciones

 **CHAUVIN
ARNOUX**

Meaning of the  symbol

Warning ! Please refer to the User's Manual before using the instrument.

In this User's Manual, the instructions preceded by the above symbol, should they not be carried out as shown, can result in a physical accident or damage the instrument and the installations.

Meaning of the  symbol

This device is protected by a double insulation or by a reinforced insulation. No linking is required from the protection earth terminal to ensure the electrical security.

You have just acquired a ground tester and we thank you for your confidence.

To get the best service from your instrument:

- **read** carefully this User manual
- **respect** the operating precautions detailed within.



SAFETY PRECAUTIONS



- Do not use the clamp on cables where the voltage exceeds 150 V RMS or DC in relation to the earth in category III Pollution 2.
Category III meets with the strict requirements concerning reliability and environmental constraints, corresponding to permanent use on fixed industrial installations, as defined in the IEC 664-1.

Note: The label that you stick to the back of your instrument reminds you of the values that must not be exceeded, the measurement ranges, and briefly, the operation of the clamp.

- Avoid any shock to the measurement head, especially to the jaw faces.
- Keep the surfaces of the jaw faces clean. Even slight soiling may cause malfunction of the clamp.
- Avoid the immediate proximity of metallic masses (see distortion parameters).
- With the recorded or programmed values saved, it is advisable to switch OFF the instrument between each measurement, to increase the service life of the clamp.
- Do not exceed the permissible overloads of loop current (see general specifications).
- Do not leave the battery in the instrument in case of prolonged non-use.
- Opening of covers or removal of elements (apart from those that can be manipulated by hand) risks giving access to parts that are dangerous to touch. The instrument must be disconnected from any source of power supply before being opened for any adjustment, replacement, maintenance or repair.
- When risk-free operation is no longer possible, the instrument must be taken out of service and protected from any untimely operation.

SUMMARY

	Page
WARRANTY	28
TO ORDER	28
PRESENTATION	29
DESCRIPTION (diagrams at end of user's manual)	29
Instrument	29
Display	30
"How to use" labels	31
PRINCIPLE OF MEASUREMENT	32
OPERATION	33
ON/OFF Function	33
Choice of the measurement unit	33
Hold digital value on the display	33
Alarms (C.A 6415 and C.A 6415R only)	34
Operation of the alarm	34
Setting the alarm threshold	34
Memory (C.A 6415 and C.A 6415R only)	35
Zero reset of memory	35
Recording a measurement	35
Reading recorded measurements	36
Special functions	36
Auto ON/OFF	36
Buzzer ON/OFF (C.A 6412, C.A 6415 and C.A 6415R)	36
Special symbols	37
SUMMARY OF FUNCTIONS	38
EXAMPLES OF DISPLAYS	39
EXAMPLES OF USE	40
Testing a loop connected to an extended earth	40
Testing the equipotential of grounding systems	41
SPECIFICATIONS	42
General specifications	42
Metrological specifications	43
MAINTENANCE	46
Cleaning	46
Calibration	46
Changing the battery	46
Calibration check	47
Repair	47
APPENDIX (operation of buzzer)	48

WARRANTY

Our guarantee is applicable for **twelve months** after the date on which the equipment is made available (extract from our General Conditions of Sale, available on request).

TO ORDER

	Reference
GROUND TESTER C.A 6410	P01.1220.11
GROUND TESTER C.A 6412	P01.1220.12
GROUND TESTER C.A 6415	P01.1220.13
GROUND TESTER C.A 6415R	P01.1220.14

*Comes in carry case with a 9 V battery,
a set of 5 "How to use" labels (5 languages)
and a User's Manual.*

Accessory

Calibration loop CL1	P01.1223.01
----------------------------	-------------

Spare

Carry case MLT 100	P01.2980.11
--------------------------	-------------

PRESENTATION

The Earth Tester is designed for testing the resistances of any system of conductors which is a conductive loop.

In particular, it enables measurements of earth resistances if it is in series in a loop with its continuity conductor and different earths (extended earth produced for example by means of a guard wire linking electricity pylons together, for energy transportation or telecommunications; earths connected to one ground only).

DESCRIPTION

(diagrams at end of user's manual)

INSTRUMENT

All models

- 1 : Display
- 2 : Trigger used for opening the measurement head
- 3 : Measurement head
- 4 : **HOLD** button
 - Allows the user to freeze the displayed values and different functional symbols
 - Used in combination with the ON/OFF button (secondary function), allows the user to switch off the Auto Off.
- 5 : **ON/OFF** button
 - To switch **ON/OFF** the instrument.
 - In combination with another pushbutton gives access to the secondary functions. (models C.A 6412 and C.A 6415 only)

Models C.A 6412, C.A 6415 and C.A 6415R only

- 6 : **Ω** pushbutton
 - Allows the user to return to the loop resistance measurement function, after this function has been exited.
 - In combination with the ON/OFF pushbutton (secondary function), switches the buzzer On or Off.
- 7 : **A** pushbutton
 - Allows the user to switch to current measurement function.

Models C.A 6415 and C.A 6415R exclusively

- 6 : Ω pushbutton
- On alarm reset mode, raises the alarm threshold.*
 - On read memory mode, displays the next recording.*
- 7 : \uparrow pushbutton
- In combination with the ON button (secondary function), switches On or Off the measurement recording mode.
 - In reset alarm mode, lowers the alarm threshold.*
 - In read memory mode, displays the preceding recording.*
- 8 : **AL** pushbutton
- Switches the alarm function On or Off.
 - In combination with the ON button (secondary function), switches to reset alarm threshold mode.
- 9 : **MEM** pushbutton
- Records the measured value in Ω (resistance), or A (current).
 - In combination with the ON button (secondary function), switches to read memory mode when you want to reread the recorded values. Also allows you to reset the memory to zero, by holding the sequence ON + MEM.

* if buttons Ω or A are pressed down and held, the values scroll at a rate of 3 per second, then 10 per second after they have been pressed for 5 seconds.

DISPLAY

All models

- 10 : 4 digit LCD digital display
- 11 : buzzer on
- 12 : HOLD symbol for display of the last measurement
- 13 : symbol showing the presence of interference currents in the loop such that the resistance measurement can not be guaranteed.
- 14 : symbol showing that the clamp is not correctly closed, so measurement can not, in this case, be made.
- 15 : indicates a resistance less than 0.1 Ω , limit below which the accuracy of the measurement is not guaranteed.
- 17 : resistance measurement unit
- 18 : decimal points
- 19 : service life of the battery as a % of the max. service life
- 20 : LCD digital display of the battery service life (0 to 100)
- 21 : low battery symbol
- 22 : permanent operation (Auto Off cancelled)

Note: When switching on the clamp, if the ON button is held down for more than 1 second, a quick automatic test is carried out on the entire display. All the available segments are displayed for this short time. In your User's Manual, only the segments exclusive to your clamp are shown.

Models C.A 6412, C.A 6415 and C.A 6415R only

16 : current measurement unit

Model C.A 6415 and C.A 6415R exclusively

20 : 2½ digit LCD digital display of alarm threshold.

23 : unit reminding you that the alarm is linked to the resistance measurement.

24 : set alarm threshold or alarm function mode.

25 : symbol showing that alarm threshold has been triggered by a low value.

26 : symbol showing that alarm threshold has been triggered by a high value.

27 : 2 digit LCD of number of current memory.

28 : re-read memory mode.

29 : record in memory mode.

"HOW TO USE" LABELS

Five adhesive stickers are supplied with your earth tester. They are condensed versions of the user's manual in 5 languages. Choose your label and stick it to the back of your instrument. This label will always remind you of the basic information which is essential for using your clamp.

PRINCIPLE OF MEASUREMENT

The diagram below of the principle of measurement illustrates the general case of measurement of a loop resistance consisting of:

- the ground rod R_x
 - the Earth
 - n ground rods
 - a guard wire looping together all these earths
- The generating winding of the clamp develops an AC voltage with a constant level E .
- The current measurement winding in the clamp has the value $I = E/R_{loop}$
 Knowing E set by the generator and I measured, we can deduce R_{loop}
 (value displayed on the clamp).
- More generally, this principle makes it possible to find defective earths. In fact, the loop resistance is composed of:
- R_x (value to be found)
 - R_{earth} (value normally very low less than 1Ω).
 - $R_1 // R_2 ... // R_n$ (negligeable value: case for multiple parallel earths).
 - $R_{guard\ wire}$ (value normally very low, less than 1Ω).
- $R_{loop} = R_x + R_{earth} + (R_1 // R_2 ... // R_n) + R_{guard\ wire}$
 By approximation, $R_{loop} = R_x$.
 If this value is very high, an inspection of this earth rod is strongly recommended.

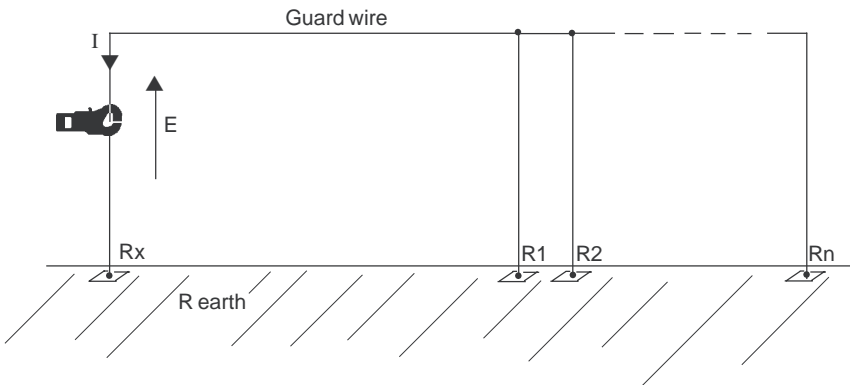

OPERATION

ON/OFF OPERATION

ON/OFF switches ON, OFF, and gives access to the secondary functions of the instrument.

When switched ON, if the ON button is still pressed, the whole display is lit. After being pressed for 2 seconds, the remaining service life of the battery is displayed as a % (display of flashing  symbol). Model C.A 6415 also states the number of recordings that have already been carried out (displays flashing **MEM** symbol).

As soon as it is switched ON, the clamp configures itself for resistance measurement (Ω). The buzzer function is activated or not (on models C.A 6412, C.A 6415 or C.A 6415R), depending on its state when the clamp was last turned off. This is the same for the memory and alarm functions on models C.A 6415 and C.A 6415R.

CHOICE OF THE MEASUREMENT UNIT

Measurement in Ω

After pressing ON or after switching on, the instrument performs a resistance measurement.

OL on the main display indicates that the value of resistance measured exceeds the measurement range.

---- on the main display indicates either that the clamp is open, or that dirt is stopping the clamp from closing correctly. The  symbol is present on the display.

Measurement in A (models C.A 6412, C.A 6415 and C.A 6415R only)

After A is pressed, the instrument performs a current measurement.

OL on the main display indicates that the value of the current measured exceeds the measurement range.

HOLD DIGITAL VALUE ON THE DISPLAY

This function is accessible with the HOLD button, only on measurement mode.

Press **HOLD** to freeze the last measurement displayed. The **HOLD** symbol is displayed and the A, Ω and AL (models C.A 6412, C.A 6415 and C.A 6415R only) buttons are inoperative. Recording of the measurement is possible if memory mode is ON (C.A 6415 and C.A 6415R exclusively). In this case, the **NOISE** and **R < .1 Ω** symbol are also recorded in memory if displayed.

Press the HOLD button again to reset the instrument to instantaneous measurement mode and **HOLD** disappears from the display.

ALARMS (C.A 6415 and C.A 6415R exclusively)



Operation of the alarm

On resistance measurement, the alarm function is switched ON with the **AL** button (the **AL** symbol and the value of the alarm threshold are displayed).

- A switch located inside the instrument allows the choice of the type of alarm used:
- Low alarm: indicates measurements below the alarm threshold.
 - High alarm: indicates measurements above the alarm threshold.

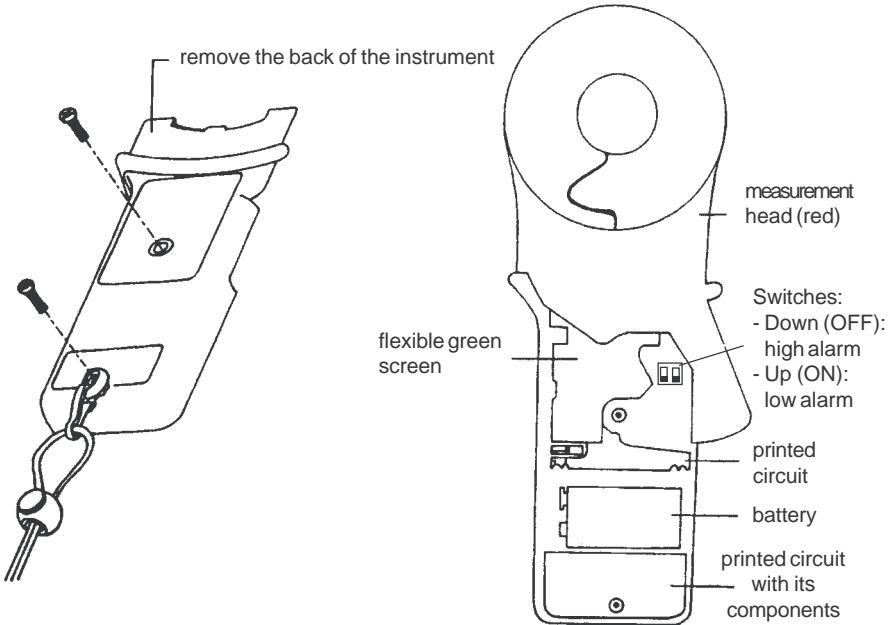
When supplied, the switch is set to the high alarm position. To modify the type of alarm, unscrew the back of the instrument and change the position of the switch (see diagram below).





According to the type of alarm selected, crossing of the alarm threshold will be indicated by the appearance of  or  and a continuous beep at high or low frequency.

Press the **AL** button again to exit the alarm function (the **AL** symbol disappears). If the instrument is switched OFF, without the alarm mode being exited, this configuration will be saved. The instrument will thus automatically switch the alarm function ON again when the instrument is next switched ON.

Setting the alarm threshold

To programme the alarm threshold for resistance measurement it is necessary to first press the **ON + AL** sequence.

The **AL** symbol is displayed and the last digit of the threshold value flashes, as a reminder that you are in threshold reset mode. This value is changed by pressing the  button (increase) or  button (decrease). This new threshold value will be kept until it is again changed, even after the clamp has been switched OFF.

The high alarm threshold can be between 1 and 199 Ω . It is programmed in at the factory before delivery of the clamp.

OFF (instrument switched off) exits alarm threshold programming mode.

MEMORY (C.A 6415 and C.A 6415R exclusively)



Zero reset of memory

Press the **ON + MEM** sequence for 3 seconds to display  r, this starts the clear memory procedure. At the 5th beep, the memory is cleared. Return to resistance measurement is then automatic.

Recording a measurement

The recording of a measurement is only possible if the memory is switched on with the **ON + A** sequence (**MEM** symbol displayed).

Press **MEM** to record the displayed value. The number of values in memory goes up by 1 and a long beep confirms the recording.

If the  symbol or the  symbol is continuously displayed, recording is impossible because the clamp is not correctly closed or the battery is too low.

When the 99th value is recorded, the **MEM** symbol flashes to tell the user that the memory is full. It is then no longer possible to record new values. If **MEM** is pressed again there is no effect other than that a beep is emitted to indicate that recording is prohibited. The memory should be reset to zero (after being re-read if necessary).

Press sequence **ON + A** to exit the instrument from memory mode (the **MEM** symbol disappears from the display). If the instrument is switched off without memory mode being exited, this configuration will be saved.

The instrument will therefore automatically reset to memory mode when it is next switched on again.

Unless the memory is reset to zero, all the recordings are saved even after the instrument is switched off or the battery disconnected (instrument OFF).



Reading recorded measurements

A short press on **ON + MEM** allows you to consult the memory.

The **MR** symbol is displayed, as well as the number of the recording shown.



if **ON + MEM** are pressed and held for 6 seconds the memory will be reset to zero.

To display the values recorded in memory press the  button (subsequent recordings) and  (previous recordings).

The last digit of the recording number flashes to show that you are in read mode.

OFF (instrument off) allows the user to exit read memory mode.

SPECIAL FUNCTIONS

Auto ON/OFF

Your clamp is fitted with a battery system for economising battery power.

After approximately 5 minutes operation of the battery, if no button on the clamp has been pressed, the instrument switches off automatically. 15 seconds before switching off, a short beep warns the user, whilst the display starts to flash.

Auto Off can be deactivated by pressing the sequence **ON + HOLD**. In this case, the instrument operates continuously (the symbol  is displayed) and the instrument will only switch off when the user presses the **OFF** button.

Continuous operation is cancelled when the instrument is switched off.

Buzzer ON/OFF (models C.A 6412, C.A 6415 and C.A 6415R only)

Your clamp is fitted with a powerful buzzer whose different beeps indicate the state of the instrument (see: Table of buzzer operation in Appendix).



If necessary, the buzzer operation can be switched OFF by pressing the sequence **ON + Ω**. In this case the  symbol disappears.

This deactivation of the buzzer will be saved on models, even after the instrument is switched off. Press **ON + Ω** again to switch on the buzzer again (the  symbol will appear again).

SPECIAL SYMBOLS



In addition to the battery service life which is accessible when **ON** is pressed when switching on, the clamp can display the battery level at any time:

For an alkaline battery if the service life is less than 25 %: the  symbol flashes, indicating that around 50 resistance measurements can be made with guaranteed values. If it is less than 20 %: the  symbol is continuously displayed, measurements are only indicative, they can not be recorded in the memory.

When the battery is flat, the instrument switches off automatically.

NOISE

This symbol appears when a disturbing current which is too great circulates in the earth conductor, i.e. when the product $U = R_{\text{loop}} (I_{\text{disturb.}} + I_{\text{meas.}})$ is greater than approximately 40 V. Resistance measurement is not then guaranteed.



This symbol appears when the clamp is open or incorrectly closed. It may be displayed on the screen when the jaw faces are not perfectly clean.

The clamp can not make a measurement in this case.

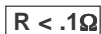

This symbol appears when the resistance measured is less than 0.1 Ω

OL

This appears on the digital display when the measured value exceeds the measurement range (1200 Ω in resistance measurement on all models, 30 A in current measurement on the C.A 6412, C.A 6415 and C.A 6415R accompanied with an intermittent beep).

SUMMARY OF FUNCTIONS

Function	Pushbutton
----------	------------

All models

ON/OFF *	ON/OFF
HOLD display	HOLD
P - Switch Auto Off ON/OFF	ON + HOLD

* The instrument is automatically on Ω units each time it is switched on.

Models C.A 6412, C.A 6415 and C.A 6415R only

Ω measurement *	Ω
A measurement	A
●)) - Switch buzzer ON/OFF **	ON + Ω

* The instrument is automatically on Ω units each time it is switched on.

** Function saved, even after the instrument is switched off.

Model C.A 6415 and C.A 6415R exclusively :

Programming alarm threshold in Ω	ON + AL then Ω or \bar{A}
AL - Switch alarm ON/OFF**	AL
MEM - Access to memory mode**	ON + A
Record measurement	MEM
MR - Re-read recorded measurements	ON + MEM (press < 2 s) then Ω or \bar{A}
Reset memory to zero	ON + MEM (press > 6 s)

** Function saved, even after the instrument is switched off.

EXAMPLES OF DISPLAYS

- Buzzer ON
- Measurement of a loop resistance of 28.1 Ω
- 8 recorded values in the memory (C.A 6415 and C.A 6415R exclusively)
- Battery o.k.
- Clamp correctly closed
- No interference current disturbing the measurement
- Alarm off (C.A 6415 and C.A 6415R exclusively)



- Buzzer ON
- Display HOLD on the last measurement of 16.8 A (C.A 6412, C.A 6415 and C.A 6415R only)
- 9 measurements have been recorded (C.A 6415 and C.A 6415R exclusively)
- The battery is low and must be changed, nevertheless the measurement is still valid.

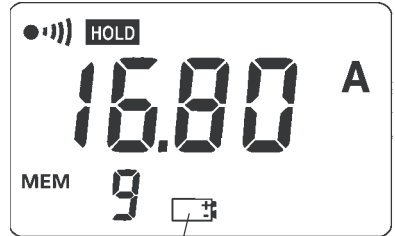

- Buzzer ON
- The current measurement is less than 0.1 Ω , the displayed value (0.08 Ω) is therefore not guaranteed.
- The memory is full because 99 values are recorded (C.A 6415 and C.A 6415R exclusively).
- The alarm threshold, set at 15 Ω , is on. The low alarm arrow is displayed to indicate that this threshold has been crossed (C.A 6415 exclusively).
- A continuous low frequency beep is emitted (C.A 6415 and C.A 6415R exclusively).

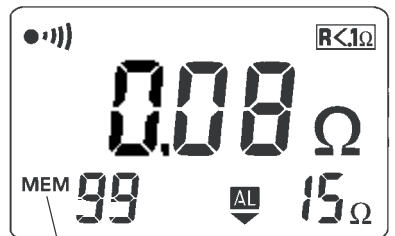

flashing

EXAMPLES OF USE

TESTING A LOOP CONNECTED TO AN EXTENDED EARTH

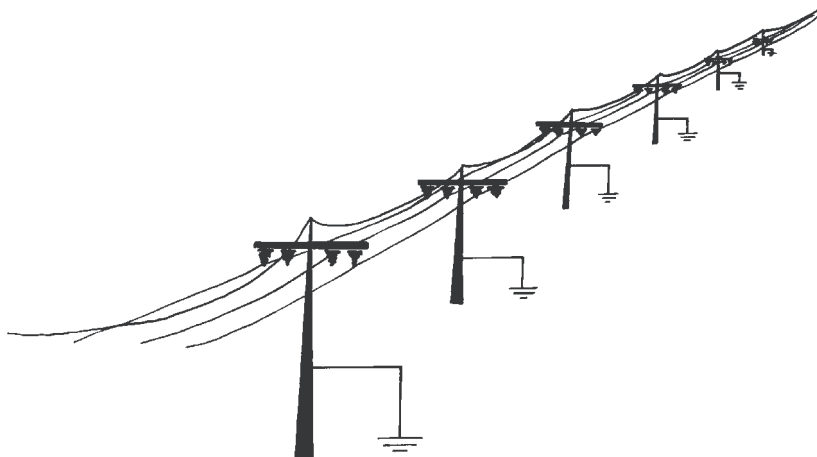

- In some countries (US, Northern Europe, ...) the electricity supply company brings the live, negative and earth conductors to the final user. In order to get a good quality for the earth present throughout the distribution network, an extended earth is constituted from all the local earths in parallel: earths of electricity pylons, earths for buildings, ...
- The railways are particularly protected from the risks of lightning or excess voltage. The catenary carrying pylons, the rails and sometimes even the fencing is connected to the earth. In addition, to get a very low value earth resistance, an interconnection between pylons - rails - fencing is made thus creating a multiple parallel earth.
- In order to protect lines from any disturbance, "FRANCE TELECOM" insulates the cables by means of a conductive sheath regularly connected to the earth throughout its length.

In the cases cited above, to rapidly check the efficiency of these multiple earths:

- successively insert the clamp around each conductor connected to the earth
- read the value attained in Ω on the display
- the resistance of the earth in question will be less than or equal to the value measured in this way.

Analysis: The values read must never exceed a few ohms, or a few tens of ohms. Higher values indicate the presence of a fault in the earth loop tested. Comparison with nearby loop values will allow you to locate the common faulty link. This must be subjected to further investigation: measurement of the continuity of the cable connected to the earth, measurement of the resistance of local earths isolated from the rest of the network, ...

Note: With models C.A 6415 and C.A 6415R it is also possible to record each measurement during a series of tests, and to trigger an alarm if the fixed threshold value put in by the operator is exceeded.

TESTING THE EQUIPOTENTIAL OF GROUNDING SYSTEMS

In establishments equipped with sensitive electronics, protection is reinforced by a mesh of grounding conductors, connected to multiple earths. An extended earth is thus obtained which makes it possible to produce a grounding system without equipotential defects.

To guarantee a perfect flow of loads to the earth, the resistive values of the loops formed by these means must be low, but also, practically identical. A loop with a value different from the rest of the grounding system would be likely to create a difference in potential, for example, in case of lightning.

This excess voltage is likely to cause serious damage to sensitive equipment. Your clamp allows you to easily check your earth meshes, and therefore to guarantee the equipotential:

- Measure the resistive value of each loop.
- Compare all the measurements with one another.

Analysis: See preceding analysis and note.



General remark on loop measurement

Note that for the measurements discussed up to this point, we mention "loop resistance". Given the principle of the measurement clamp and the measurement signal generated (2403 Hz for C.A 6410, C.A 6412 or C.A 415 and 1358 Hz for C.A 6415R), it would be more correct to speak of the measurement of "loop impedance".

In fact, in practice the reactive values in series in the loop (in line choke) can be ignored in relation to the loop resistance ($Z \approx R$).

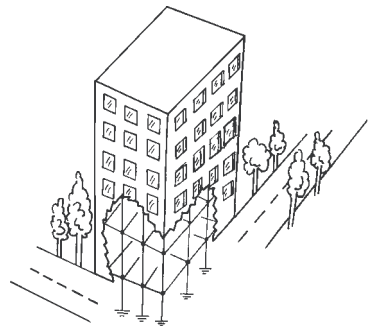

SPECIFICATIONS

GENERAL SPECIFICATIONS

Conformity to the EN 6110-1 Ed 95 standard:

Instrument completely protected by double insulation

EN 61010-2-032 Ed 95, 150 V, category III and degree of pollution 2 (class 2).

Leakage line and distance in the air: 3.3 mm minimum

Emission: NF EN 61326-1, ed 98

Immunity: NF EN 61326-1, ed 98

Limiting overloads: permanent current 100 A max. (50/60 Hz)
transient currents (< 5 s) 200 A (50/60 Hz)

Case: polycarbonate

Dimensions: 55 x 100 x 240 mm

Max. Clamping diameter: 32 mm Ø

Weight: approx. 1 kg

Watertightness: IP30, Group III equipment as per EN 60529 Ed 92
IK04, as per EN 50102 Ed 95

Power supply: - 9 V alkaline battery 6LF22 or equivalent
- average consumption: approx. 40 mA
- average service life: approx. 8 hours,
i.e. 1000 measurements of 30 seconds.
With a rechargeable NiCad battery, the average service life is
approx. 400 measurements of 30 seconds.

Note: extreme environmental conditions may disturb the internal microprocessor.
Simply disconnecting the battery may be sufficient to eradicate this malfunction.

METROLOGICAL SPECIFICATIONS

Reference conditions

Distortion conditions	Reference conditions
Ambient temperature	23°C ± 3 K
Relative humidity	50% RH ± 10%
Battery voltage	8 V ± 0.2 V
External magnetic field	< 40 A/m
External electric field	< 1 V/m
Operating position	Clamp horizontal
Position of conductor in the clamp	centred
Proximity to metallic mass	> 10 cm
Loop resistance	Non choke resistance
Current measured, sinusoidal frequency	50 Hz
Rate of distortion	< 0.5%
Interference current on measurement of loop resistance	nil

Climatic conditions

- 1 Reference range
- 2 Operating range
- 3 Storage range: (internal or external use of equipment)

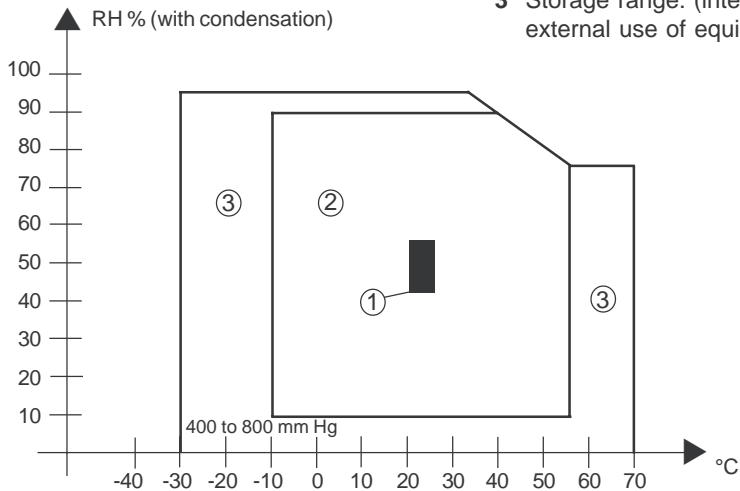

Ω function (resistance measurement) for reference conditions

Measurement ranges in Ω	0.1 to 1.00 ⁽¹⁾	1.0 to 50.0	50.0 to 100.0	100 to 200	200 to 400	400 to 600	600 to 1200
Resolution	0.01 Ω	0.1 Ω	0.5 Ω	1 Ω	5 Ω	10 Ω	50 Ω
Accuracy	±1.5% ±0.02 Ω	±1.5% ±0.1 Ω	±2% ±0.5 Ω	±3% ±1 Ω	±6% ±5 Ω	±10% ±10 Ω	approx. 25% ±50 Ω

⁽¹⁾ Indication of measurements up to approximately 0.07 Ω, but accuracy is not guaranteed below 0.1 Ω

Hysteresis of the display	± 20 to 30% of the resolution
Switching of automatic ranges	Switching at 100 Ω for increasing value and at 91Ω for decreasing value
Loop voltage generated ⁽¹⁾	Approx. 60 mV rms at 2 403 Hz for C.A 6410, C.A 6412, C.A 6415 and 1358 Hz for C.A 6415R. Shape : sinusoidal (For R loop of 1 Ω to infinity)
Alarm	- Threshold range: 1 Ω to 199 Ω - Hysteresis: 3 times the resolution

⁽¹⁾ The voltage generated in the loop is "pulsed" in such a way as to save on the battery. The loop is excited for approximately 60 ms, 4 times a second, i.e. 24% of the time.

"A" function (AC current measurement) for the reference conditions

Measurement range	0 ... 299 mA RMS	0.300 ... 2.999 A RMS	3.00 ... 29.99 A RMS
Resolution	1 mA	1 mA	10 mA
Accuracy in % of the reading	± 2.5 % ± 2 mA	± 2.5 % ± 2 mA	± 2.5 % ± 20 mA
Switching of automatic range	Switching at 3000 counts for increasing value and at 270 counts for decreasing value		

Variations in the nominal working range

Influence parameter	Limit of operating range	Parameter influenced	Influence (1)	
			typical	Max.
Temperature	- 10 °C to +55°C	A	0.5 P/10°C	1.5 P/10°C + R
		Ω	(0.05 Ω + 0.5 P)/10°C	(0.05 Ω + 1.5 P)/10°C + R
Relative humidity	10 % RH to 90 % RH	A	0.5 P	P + R
		Ω	0.05 Ω + 0.5 P	0.05 Ω + P + R
Battery voltage	6.5 to 9.5 V	A and Ω	0.1 P	0.25 P + R
Conductor position	from edge in centre	A	0.05 P	0.2 P + R
		Ω	0.05 P	0.1 P + R
Clamp position	± 180 °	A and Ω	0.1 P	0.2 P + R
Proximity of earth magnetic	1 mm steel sheet against jaw gap	Ω	0.1 P	0.5 P + R
Magnetic field 50/60 Hz	30 A/m	Ω and A	0.05 P	0.1 P + R
Frequency	47 ... 800 Hz	A	2 P	3 P + R
Disturbing current 50 ... 60 Hz in the loop (2)	$(I_{\text{meas.}} + I_{\text{disturb.}}) \times R_{\text{loop}} \leq 40 \text{ V}$	Ω	3 % L	5 % L + R
			For $I \leq 1 \text{ A}$ With $R_{\text{measured}} = 30 \text{ Ω}$	
Peak factor (3)	1.4 to 2.5	A	1 P	1.5 P + R
	2.5 to 5		2 P	2.5 P + R

(1) P = Precision defined in the reference conditions for the measuring range considered

R = Resolution defined for the measuring range considered

% L = Error expressed as a percentage of the reading (L)

Example: For a measured value of 25 Ω at 20°C, the maximum influence of temperature is:

$$[0.05 \text{ Ω} + (1.5 \times 0.015 \times 25)] / 10^\circ\text{C} \pm 0.1 \text{ Ω} \text{ or } 0.61 \text{ Ω} / 10^\circ\text{C} \pm 0.1 \text{ Ω}$$

(2) The disturbing current at 50/60 Hz maximum is approximately 3.5 A for low loop resistance values (< 10 Ω).

Above approximately 40 V (at 50/60 Hz) in the measuring loop, the NOISE symbol comes on..

(3) Limited to 40 A peak

MAINTENANCE



For maintenance, use only specified spare parts. The manufacturer will not be held responsible for any accident occurring following a repair done other than by its After Sales Service or approved repairers.

CLEANING

- The jaw faces must be cleaned with a soft cloth.
- Use only a damp cloth to clean the case. Abrasive products or solvents are prohibited. A little soap may nevertheless be used.

CALIBRATION

- Calibration must be done more frequently for more intensive use.
- With the calibration loop which is sold as an accessory, you may yourself at any time check the accuracy of your clamp. To do this enclose the calibration loop in the jaws of the clamp. Switch ON your clamp, then compare the displayed measurement with the value marked on the enclosed segment. Proceed like this for each calibration value of the calibration loop. Depending on the measurement differences read, you can decide on the necessity of having your clamp recalibrated. In this case, get in touch with your supplier.

Calibration values of the loop: 7.9 Ω / 12.4 Ω / 22 Ω / 49.5 Ω / 198 Ω

Accuracy of these values 0.3 % typical and 0.5 % max.

Note: Add the accuracy of the instrument to the accuracy of the calibration values.

CHANGING THE BATTERY

- With the instrument switched OFF, the battery is changed by unscrewing the two screws on the back of the instrument. When the battery is disconnected, the configuration (buzzer, ...), as well as the recorded measurement values (C.A 6415 and C.A 6415R), and the value of the alarm threshold (C.A 6415 and C.A 6415R) are saved.
- Replace the used battery by a new one of the same type (alkaline 9 V battery or equivalent).
- Respect the polarity when connecting.



CALIBRATION CHECK

It is essential that all measuring instruments are regularly calibrated.

We advise you to check this instrument at least once a year. For checking and calibration of your instrument, please contact our accredited laboratories (list on request) or the Chauvin Arnoux subsidiary or Agent in your country.

REPAIR

Repairs under or out of guarantee: please return the product to your distributor

APPENDIX

Descriptive table for operation of buzzer

	Length and frequency of beep					
	65 ms		125 ms	250 ms	Continuous	
	2.5 kHz	4 kHz	2.5 kHz	1 kHz	1 kHz	4 kHz
Press button	X					
- Button prohibited - Recording not possible		X				
Noise		Intermittent				
Current overload		Intermittent				
Alarm crossed					low alarm	high alarm
Variation after memorisation or clear				X		
Warning before initialisation			5 beep			
Warning before Auto off.	X					